

F.TÉCNICA

LAMA DE ALUMINIO

1770 x 150 x 20 mm

IMPORTANTE: Verifique siempre que se trata de la última versión de este documento en www.dioco.es

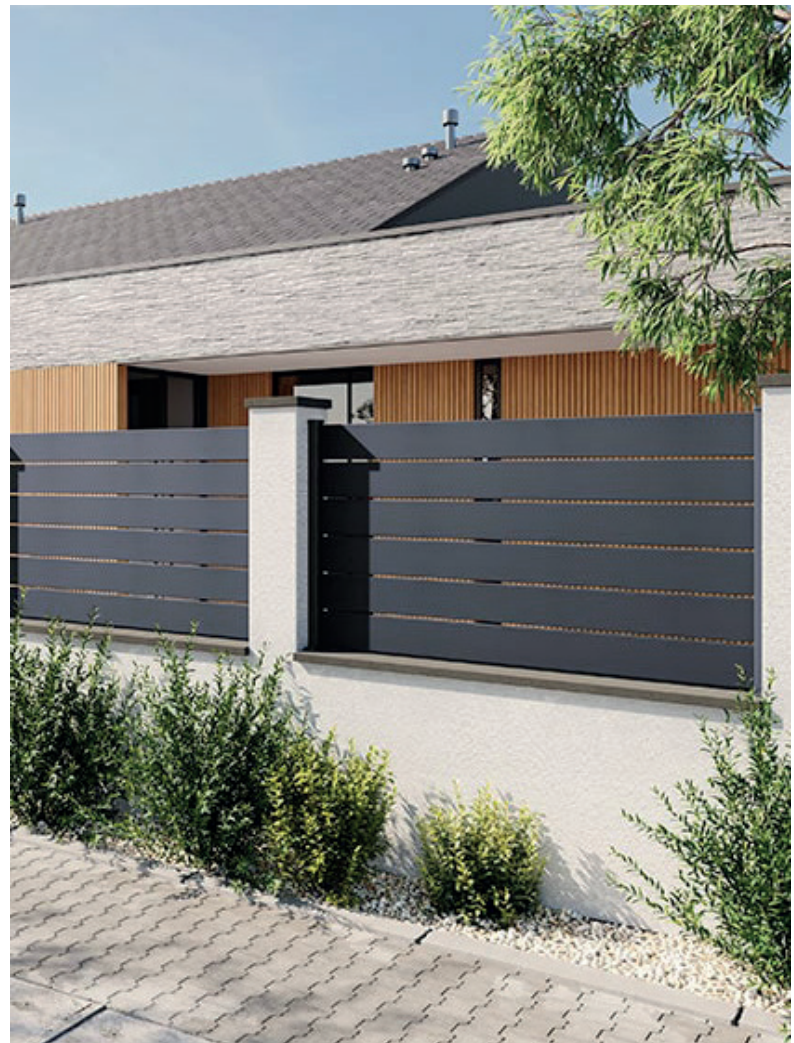

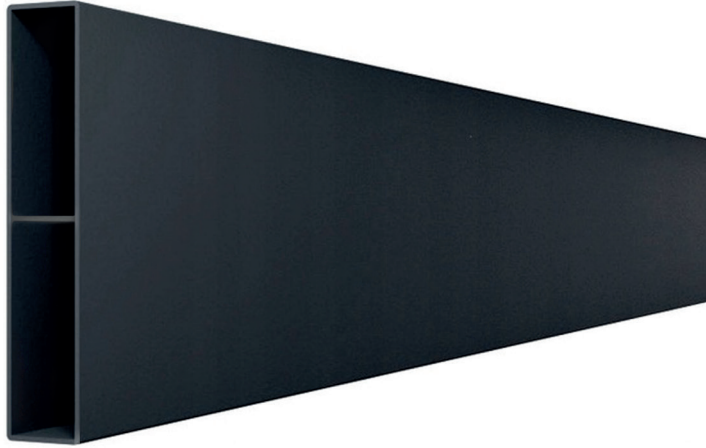

LOGÍSTICA LAMA DE ALUMINIO

Uds./pack:	6 uds.
Peso pack:	15,3 kg.
Packs/palé:	35 uds.
Peso palé:	534,1 kg.
Palé:	1775 x 815 x 112 mm

LOGÍSTICA LAMA PERSIANA ALUMINIO

Uds./pack:	6 uds.
Peso pack:	15,3 kg.
Packs/palé:	35 uds.
Peso palé:	534,1 kg.
Palé:	1775 x 815 x 112 mm



COLORES DISPONIBLES:



Blanco

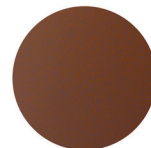

Óxido



Gris

LAMA ALUMINIO



LAMA PERSIANA ALUMINIO

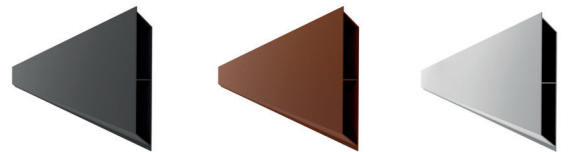

CARACTERÍSTICAS TÉCNICAS

Material:	Aluminio 6063 T6
Tratamiento superficial:	Lacado Qualicoat
Apto para exteriores:	Si
Sistema de fijación:	Atornillado al suelo (placa base)
Colores disponibles:	Gris, blanco y óxido
Garantía:	20 años

F.TÉCNICA

LÂMINA DE ALUMÍNIO

1770 x 150 x 20 mm

IMPORTANTE: Verificar sempre a versão mais recente deste documento em www.dioco.pt

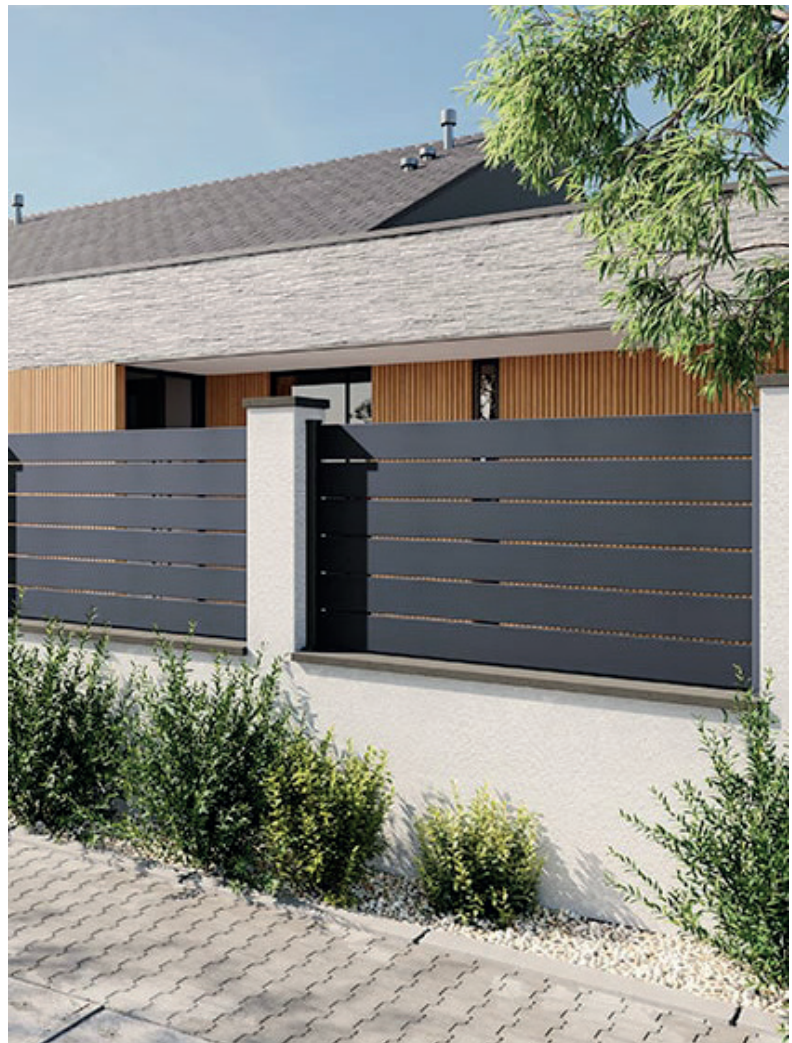

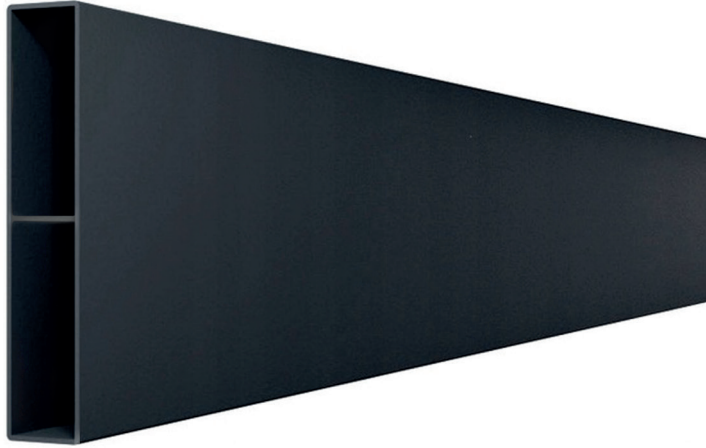

LOGÍSTICA LÂMINA DE ALUMÍNIO

Uds./embalagem:	6 uds.
Peso embalagem:	15,3 kg.
Embalagens/palete:	35 uds.
Peso do palete:	534,1 kg.
Dimensões do palete:	1775 x 815 x 112 mm

LOGÍSTICA LÂMINA PERSIANA DE ALUMÍNIO

Uds./embalagem:	6 uds.
Peso embalagem:	15,3 kg.
Embalagens/palete:	35 uds.
Peso do palete:	534,1 kg.
Dimensões do palete:	1775 x 815 x 112 mm



CORES DISPONÍVEIS:



Branco

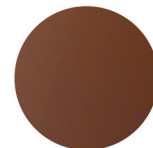

Óxido



Cinzentos

LÂMINA DE ALUMÍNIO

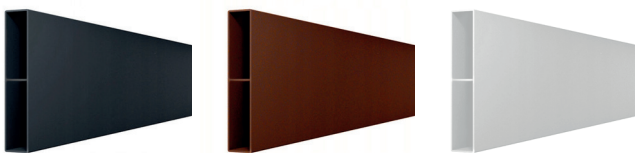

LÂMINA PERSIANA DE ALUMÍNIO

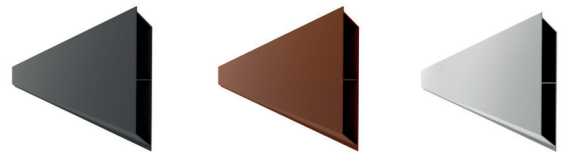

CARACTERÍSTICAS TÉCNICAS

Material:	Alumínio 6063 T6
Tratamento superficial:	Lacado Qualicoat
Apto para exteriores:	Sim
Sistema de fixação:	Aparafusado ao solo (placa de base)
Cores disponíveis:	Cinzentos, branco e óxido
Garantia:	20 anos

F.TÉCNICA

MEDIO POSTE DE ALUMINIO

1000 mm y 2000 mm

IMPORTANTE: Verifique siempre que se trata de la última versión de este documento en www.dioco.es



LOGÍSTICA MEDIO POSTE ALUMINIO 1 000 mm

Uds./pack:	2 uds./pack
Peso pack:	3,1 kg.
Packs/palé:	70 uds.
Peso palé:	218,4 kg.
Palé:	985 x 1040 x 800 mm

LOGÍSTICA MEDIO POSTE ALUMINIO 2 000 mm

Uds./pack:	2 uds./pack
Peso pack:	6,37 kg.
Packs/palé:	72 uds.
Peso palé:	459 kg.
Palé:	2000 x 1035 x 780 mm



COLORES DISPONIBLES:



Blanco

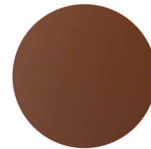

Óxido



Gris

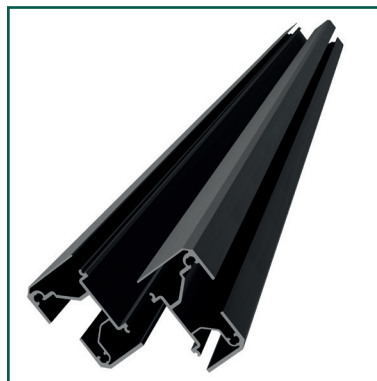
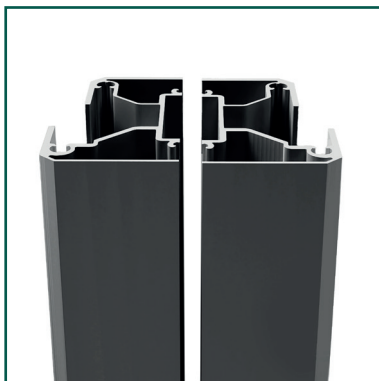
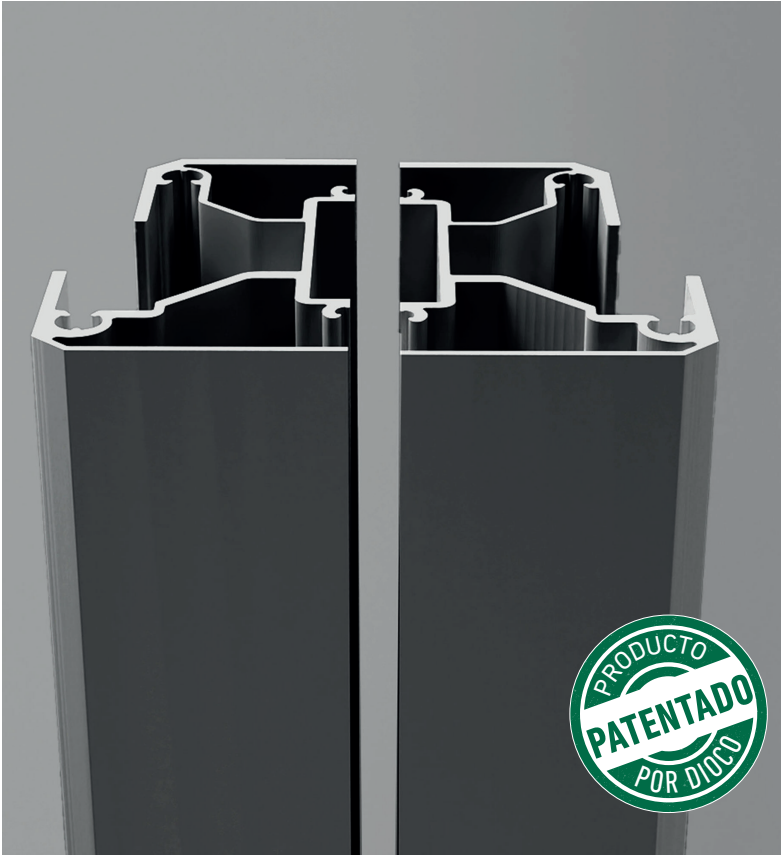

CARACTERÍSTICAS TÉCNICAS

Material:	Aluminio 6063 T6
Tratamiento superficial:	Lacado Qualicoat
Apto para exteriores:	Si
Sistema de fijación:	Atornillado al suelo (placa base)
Colores disponibles:	Gris, blanco y óxido
Garantía:	20 años

F.TÉCNICA

MEDIO PÓSTE

DE ALUMÍNIO

1000 mm y 2000 mm

IMPORTANTE: Verificar sempre a versão mais recente deste documento em www.dioco.pt





LOGÍSTICA MEDIO POSTE ALUMÍNIO 1 000 mm

Uds./embalagem:	2 uds./embalagem
Peso embalagem:	3,1 kg.
Embalagens/palete:	70 uds.
Peso do palete:	218,4 kg.
Dimensões do palete:	985 x 1040 x 800 mm

LOGÍSTICA MEDIO POSTE ALUMÍNIO 2 000 mm

Uds./embalagem:	2 uds./embalagem
Peso embalagem:	6,37 kg.
Embalagens/palete:	72 uds.
Peso do palete:	459 kg.
Dimensões do palete:	2000 x 1035 x 780 mm



CORES DISPONÍVEIS:



Branco

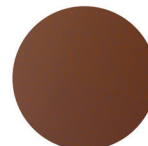

Óxido



Cinzento

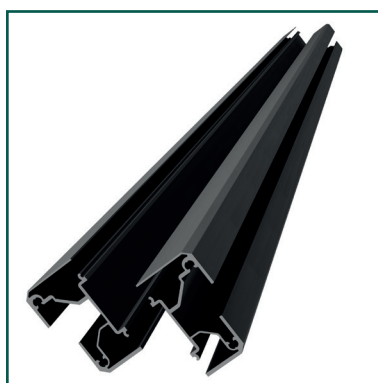
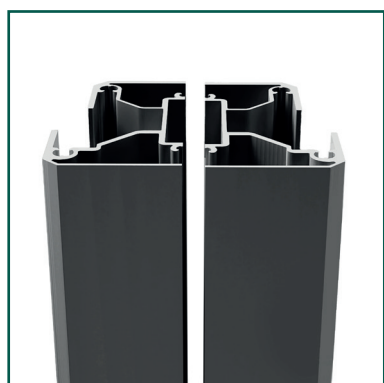

CARACTERÍSTICAS TÉCNICAS

Material:	Alumínio 6063 T6
Tratamento superficial:	Lacado Qualicoat
Apto para exteriores:	Sim
Sistema de fixação:	Aparafusado ao solo (placa de base)
Cores disponíveis:	Cinzento, branco e óxido
Garantia:	20 anos

F.TÉCNICA

POSTE DE ALUMINIO

1000 mm y 2000 mm

IMPORTANTE: Verifique siempre que se trata de la última versión de este documento en www.dioco.es





LOGÍSTICA POSTE ALUMINIO 1 000 mm

Uds./pack:	1 uds.
Peso pack:	3,1 kg.
Packs/palé:	70 uds.
Peso palé:	218,4 kg.
Palé:	985 x 1040 x 800 mm

LOGÍSTICA POSTE ALUMINIO 2 000 mm

Uds./pack:	1 uds.
Peso pack:	6,37 kg.
Packs/palé:	72 uds.
Peso palé:	459 kg.
Palé:	2000 x 1035 x 780 mm



COLORES DISPONIBLES:



Blanco

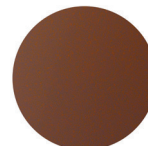

Óxido



Gris

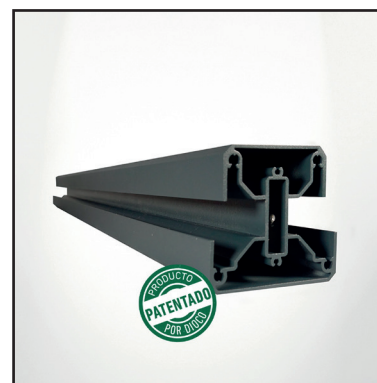

CARACTERÍSTICAS TÉCNICAS

Material:	Aluminio 6063 T6
Tratamiento superficial:	Lacado Qualicoat
Apto para exteriores:	Si
Sistema de fijación:	Atornillado al suelo (placa base)
Colores disponibles:	Gris, blanco y óxido
Garantía:	20 años

F.TÉCNICA

POSTE DE ALUMÍNIO

1000 mm y 2000 mm

IMPORTANTE: Verificar sempre a versão mais recente deste documento em www.dioco.pt





LOGÍSTICA POSTE ALUMÍNIO 1 000 mm

Uds./embalagem:	1 uds.
Peso embalagem:	3,1 kg.
Embalagens/palete:	70 uds.
Peso do palete:	218,4 kg.
Dimensões do palete:	985 x 1040 x 800 mm

LOGÍSTICA POSTE ALUMÍNIO 2 000 mm

Uds./embalagem:	1 uds.
Peso embalagem:	6,37 kg.
Embalagens/palete:	72 uds.
Peso do palete:	459 kg.
Dimensões do palete:	2000 x 1035 x 780 mm



CORES DISPONÍVEIS:



Branco

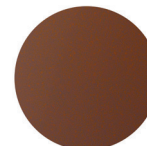

Óxido



Cinzeno

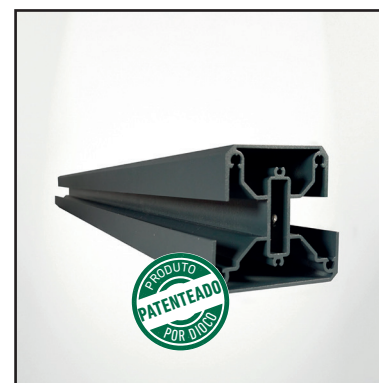

CARACTERÍSTICAS TÉCNICAS

Material:	Alumínio 6063 T6
Tratamento superficial:	Lacado Qualicoat
Apto para exteriores:	Sim
Sistema de fixação:	Aparafusado ao solo (placa de base)
Cores disponíveis:	Cinzeno, branco e óxido
Garantia:	20 anos